



FIREPLACES  
STOVES  
ACCESSORIES

# PRODUCT CATALOGUE

SEASON 2016/17

[www.hitze.company](http://www.hitze.company)







[www.hitze.comany](http://www.hitze.comany)

DISTRIBUTION  
NETWORK  
**IN EUROPE**



**FIREPLACES  
STOVES  
ACCESSORIES**

HEAD  
OFFICE

HITZE Sp. z o.o.  
ul. Gdyńska 32  
26-600 Radom

N50° 2' 27.78"  
E21° 59' 56.76"  
POLAND





We are the leading Polish manufacturer of fireplaces, pellet stoves and fireplace accessories. We supply Polish and foreign markets with top quality products manufactured by applying the latest technologies. Our products are distinguished by unique design that stylishly complements any home and corporate interior.

**NATURAL HEATING** – these words reflect the philosophy of the **HITZE** brand perfectly well.

Out of concern for the nature, we attach great importance to environmentally friendly solutions and technologies. In line with our philosophy we produce fireplaces and stoves that are fuelled by wood or wood pellets, that is raw materials being least harmful to the environment.

Thanks to up-to-date technology and long-standing experience we succeeded to create innovative solutions that are distinguished not only by care of the natural environment but also high heating efficiency.

Dynamic development of the company and cooperation with the best partners let us constantly increase our product offer and keep stable position in the market.



[www.hitze.com](http://www.hitze.com)

” Coming together is a **beginning**.  
Keeping together is **progress**.  
Working together is **success**. ”



HENRY FORD



# TABLE OF CONTENTS

- .01 CONVECTION FIREPLACE INSERTS ..... 08 - 21
- .02 WATER JACKET FIREPLACE INSERTS ..... 24 - 27
- .03 CERAMIC GLASS ..... 30 - 31
- .04 PELLET STOVES ..... 34 - 37
- .05 SUPPLEMENTARY OFFER ..... 38 - 45
- .06 TECHNICAL DATA ..... 46 - 53
- WARRANTY TERMS AND CONDITIONS ..... 54 - 55

RAL colours presented on product visualisations are for reference only and their shades may slightly differ from the real colour.

# FIREPLACE INSERTS

## CONVECTION



ALBERO line stands out by its light modern form which integrates into every living space and usable floor space very well.

It consists of six fireplace series differing in their heating power.

.01

ALBERO line







ALBERO AL 14 L.H fireplace insert



---

## ALBERO LINE

Convection fireplaces manufactured by HITZE are made of certified 3 or 4 mm thick boiler steel of P265GH grade and according to EN 1008-2 standard.

Inside every fireplace a ceramic insert is installed. It accumulates warmth in the combustion chamber and is resistant to temperatures even of up to 1000°C.

All inserts of ALBERO line are equipped with combustion gas after-burning system. After-burning system consists in a number of wholes appropriately matched to every insert which regulate the intake air volume.

It is responsible for burning economy, reduces emission of harmful substances to the environment and improves fuel saving. In some models of fireplace inserts the air is taken in through the holes in compacted concrete. Fireplace inserts are equipped with an air inlet with a regulated throttle and special feet allowing for optimum insert levelling even on uneven surface.

The fireplace insert door frame is made of a profile which guarantees door tightness and proper rigidity as well as optically increases the furnace size.

**ADVANTAGES OF CONVECTION INSERTS**

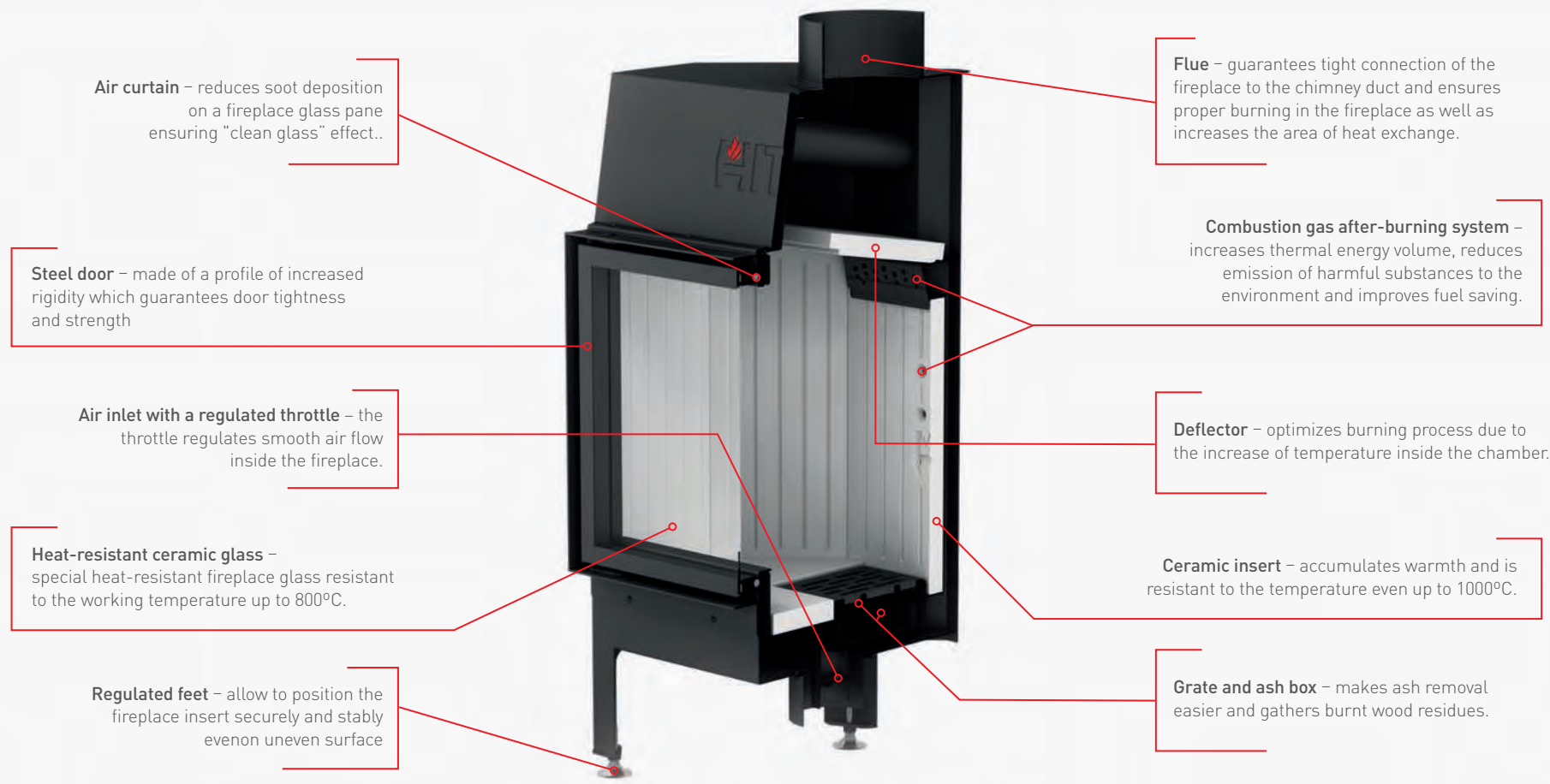





# FIREPLACE INSERTS OF HEATING POWER 9 kW

AL9 **S.H** standard horizontal fireplace insert

AL9 **S.V** left horizontal fireplace insert

AL9 **G.V** guillotine-type horizontal fireplace insert

AL9 **G.H** guillotine-type horizontal fireplace insert

AL9 **R.H** right horizontal fireplace insert

AL9 **L.H** left horizontal fireplace insert

AL9 **RG.H** right guillotine-type horizontal fireplace insert

AL9 **LG.H** left guillotine-type horizontal fireplace insert



Possibility to change the direction of insert door opening

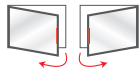

Possibility to change the direction of insert door opening

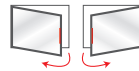

## ALBERO AL9 S.H

Nominal power **9 kW**  
Heating load range **5-10 kW**  
Weight **102 kg**  
Glass panel dimensions (mm) **545x390**



## ALBERO AL9 S.V

Nominal power **9 kW**  
Heating load range **5-12 kW**  
Weight **105 kg**  
Glass panel dimensions (mm) **390x545**



## ALBERO AL9 G.V

Nominal power **9 kW**  
Heating load range **5-12 kW**  
Weight **167 kg**  
Glass panel dimensions (mm) **390x545**



## ALBERO AL9 G.H

Nominal power **9 kW**  
Heating load range **5-10 kW**  
Weight **156 kg**  
Glass panel dimensions (mm) **545x390**



EQUIPMENT OF **9 KW SERIES** FIREPLACE INSERTS

- 🔥 Fireplace front coating – black
- 🔥 Handle colour INOX
- 🔥 Ceramic insert
- 🔥 Ceramic deflector
- 🔥 Integrated combustion gas throttle
- 🔥 Flue
- 🔥 Ash pan
- 🔥 Regulated feet 40 mm

SCAN QR CODE WITH A READER  
TO GET MORE DETAILED  
TECHNICAL DATA OF **ALBERO**  
**AL 9 KW SERIES** INSERTS



**ALBERO AL9 R.H**

Nominal power **9 kW**  
Heating load range **5-10 kW**  
Weight **109 kg**  
Glass panel dimensions (mm) **545x390x325**



**ALBERO AL9 L.H**

Nominal power **9 kW**  
Heating load range **5-10 kW**  
Weight **109 kg**  
Glass panel dimensions (mm) **545x390x325**



**ALBERO AL9 RG.H**

Nominal power **9 kW**  
Heating load range **5-10 kW**  
Weight **170 kg**  
Glass panel dimensions (mm) **545x390x325**



**ALBERO AL9 LG.H**

Nominal power **9 kW**  
Heating load range **5-10 kW**  
Weight **170 kg**  
Glass panel dimensions (mm) **545x390x325**





# FIREPLACE INSERTS OF HEATING POWER 11 kW

AL11 **S.H** standard horizontal fireplace insert

AL11 **S.V** left horizontal fireplace insert

AL11 **G.V** guillotine-type horizontal fireplace insert

AL11 **G.H** guillotine-type horizontal fireplace insert

AL11 **R.H** right horizontal fireplace insert

AL11 **L.H** left horizontal fireplace insert

AL11 **RG.H** right guillotine-type horizontal fireplace insert

AL11 **LG.H** left guillotine-type horizontal fireplace insert



Possibility to change the direction of insert door opening

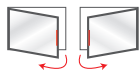

Possibility to change the direction of insert door opening

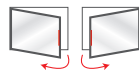

## ALBERO AL11 S.H

Nominal power **11 kW**  
Heating load range **6-13 kW**  
Weight **131 kg**  
Glass panel dimensions (mm) **590x430**



## ALBERO AL11 S.V

Nominal power **11 kW**  
Heating load range **6-12 kW**  
Weight **118 kg**  
Glass panel dimensions (mm) **430x590**



## ALBERO AL11 G.V

Nominal power **11 kW**  
Heating load range **6-12 kW**  
Weight **190 kg**  
Glass panel dimensions (mm) **430x590**



## ALBERO AL11 G.H

Nominal power **11 kW**  
Heating load range **6-13 kW**  
Weight **182 kg**  
Glass panel dimensions (mm) **590x430**



EQUIPMENT OF **11 KW SERIES** FIREPLACE INSERTS

- 🔥 Fireplace front coating – black
- 🔥 Handle colour INOX
- 🔥 Ceramic insert
- 🔥 Ceramic deflector
- 🔥 Integrated combustion gas throttle
- 🔥 Flue
- 🔥 Ash pan
- 🔥 Regulated feet 40 mm

SCAN QR CODE WITH A READER  
TO GET MORE DETAILED  
TECHNICAL DATA OF **ALBERO**  
**AL 11 KW SERIES** INSERTS



**ALBERO AL11 R.H**

Nominal power **11 kW**  
Heating load range **6-13 kW**  
Weight **144 kg**  
Glass panel dimensions (mm) **590x430x375**



**ALBERO AL11 L.H**

Nominal power **11 kW**  
Heating load range **6-13 kW**  
Weight **144 kg**  
Glass panel dimensions (mm) **590x430x375**



**ALBERO AL11 RG.H**

Nominal power **11 kW**  
Heating load range **6-13 kW**  
Weight **186 kg**  
Glass panel dimensions (mm) **590x430x375**



**ALBERO AL11 LG.H**

Nominal power **11 kW**  
Heating load range **6-13 kW**  
Weight **186 kg**  
Glass panel dimensions (mm) **590x430x375**





# FIREPLACE INSERTS OF HEATING POWER 14 kW

AL14 **S.H** standard horizontal fireplace insert

AL14 **R.H** right horizontal fireplace insert

AL14 **RG.H** right guillotine-type horizontal fireplace insert

AL14 **G.H** guillotine-type horizontal fireplace insert

AL14 **L.H** left horizontal fireplace insert

AL14 **LG.H** left guillotine-type horizontal fireplace insert

AL14 **S.V** left horizontal fireplace insert

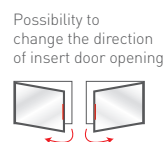
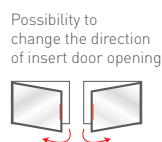

## ALBERO AL14 S.H

Nominal power **14 kW**  
Heating load range **7-16 kW**  
Weight **144 kg**  
Glass panel dimensions (mm) **680x430**



## ALBERO AL14 S.V\*

Nominal power **14 kW**  
Heating load range **7-16 kW**  
Weight **145 kg**  
Glass panel dimensions (mm) **430x680**



## ALBERO AL14 G.H

Nominal power **14 kW**  
Heating load range **7-16 kW**  
Weight **195 kg**  
Glass panel dimensions (mm) **680x430**



## ALBERO AL14 R.H

Nominal power **14 kW**  
Heating load range **7-16 kW**  
Weight **150 kg**  
Glass panel dimensions (mm) **680x430x375**





EQUIPMENT OF **14 KW SERIES** FIREPLACE INSERTS

- 🔥 Fireplace front coating – black
- 🔥 Handle colour INOX
- 🔥 Ceramic insert
- 🔥 Integrated combustion gas throttle
- 🔥 Flue
- 🔥 Ash pan
- 🔥 Regulated feet 40 mm
- 🔥 Ceramic deflector
- 🔥 \*Double ceramic deflector

SCAN QR CODE WITH A READER  
TO GET MORE DETAILED  
TECHNICAL DATA OF **ALBERO**  
**AL 14 KW SERIES** INSERTS



**ALBERO AL14 L.H**

Nominal power **14 kW**  
 Heating load range **7-16 kW**  
 Weight **150 kg**  
 Glass panel dimensions (mm) **680x430x375**



**ALBERO AL14 RG.H**

Nominal power **14 kW**  
 Heating load range **7-16 kW**  
 Weight **200 kg**  
 Glass panel dimensions (mm) **680x430x375**



**ALBERO AL14 LG.H**

Nominal power **14 kW**  
 Heating load range **7-16 kW**  
 Weight **200 kg**  
 Glass panel dimensions (mm) **680x430x375**



ALBERO AL 14 S.V fireplace insert



# FIREPLACE INSERTS OF HEATING POWER 16 kW

AL16 **S.H** standard horizontal fireplace insert

AL16 **R.H** right horizontal fireplace insert

AL16 **RG.H** right guillotine-type horizontal fireplace insert

AL16 **G.H** guillotine-type horizontal fireplace insert

AL16 **L.H** left horizontal fireplace insert

AL16 **LG.H** left guillotine-type horizontal fireplace insert



Possibility to change the direction of insert door opening

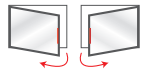

## ALBERO AL16 S.H

Nominal power **16 kW**  
Heating load range **8-19 kW**  
Weight **159 kg**  
Glass panel dimensions (mm) **680x530**



## ALBERO AL16 G.H

Nominal power **16 kW**  
Heating load range **8-19 kW**  
Weight **223 kg**  
Glass panel dimensions (mm) **680x530**



## ALBERO AL16 R.H

Nominal power **16 kW**  
Heating load range **8-19 kW**  
Weight **157 kg**  
Glass panel dimensions (mm) **680x530x375**



## ALBERO AL16 L.H

Nominal power **16 kW**  
Heating load range **8-19 kW**  
Weight **157 kg**  
Glass panel dimensions (mm) **680x530x375**



EQUIPMENT OF **16 KW SERIES** FIREPLACE INSERTS

- 🔥 Fireplace front coating – black
- 🔥 Handle colour INOX
- 🔥 Ceramic insert
- 🔥 Double ceramic deflector
- 🔥 Integrated combustion gas throttle
- 🔥 Flue
- 🔥 Ash pan
- 🔥 Regulated feet 40 mm

SCAN QR CODE WITH A READER  
TO GET MORE DETAILED  
TECHNICAL DATA OF **ALBERO**  
**AL 16 kW SERIES** INSERTS



**ALBERO AL16 RG.H**

Nominal power **16 kW**  
 Heating load range **8-19 kW**  
 Weight **220 kg**  
 Glass panel dimensions (mm) **680x530x375**



**ALBERO AL16 LG.H**

Nominal power **16 kW**  
 Heating load range **8-19 kW**  
 Weight **220 kg**  
 Glass panel dimensions (mm) **680x530x375**



ALBERO AL 16 RG.H fireplace insert



# FIREPLACE INSERTS OF HEATING POWER 19 kW

AL19 **S.H** standard horizontal fireplace insert

AL19 **R.H** right horizontal fireplace insert

AL19 **RG.H** right guillotine-type horizontal fireplace insert

AL19 **G.H** guillotine-type horizontal fireplace insert

AL19 **L.H** left horizontal fireplace insert

AL19 **LG.H** left guillotine-type horizontal fireplace insert

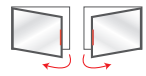

Possibility to change the direction of insert door opening



## ALBERO AL19 S.H

Nominal power **19 kW**  
Heating load range **9-23 kW**  
Weight **200 kg**  
Glass panel dimensions (mm) **900x415**



## ALBERO AL19 G.H

Nominal power **19 kW**  
Heating load range **9-23 kW**  
Weight **258 kg**  
Glass panel dimensions (mm) **900x415**



## ALBERO AL19 R.H

Nominal power **19 kW**  
Heating load range **9-23 kW**  
Weight **202 kg**  
Glass panel dimensions (mm) **900x415x375**



## ALBERO AL19 L.H

Nominal power **19 kW**  
Heating load range **9-23 kW**  
Weight **202 kg**  
Glass panel dimensions (mm) **900x415x375**



## EQUIPMENT OF **19 KW SERIES** FIREPLACE INSERTS

- 🔥 Fireplace front coating – black
- 🔥 Handle colour INOX
- 🔥 Ceramic insert
- 🔥 Double ceramic deflector
- 🔥 Integrated combustion gas throttle
- 🔥 Flue
- 🔥 Ash pan
- 🔥 Regulated feet 40 mm

SCAN QR CODE WITH A READER  
TO GET MORE DETAILED  
TECHNICAL DATA OF **ALBERO**  
**AL 19 kW SERIES** INSERTS



### ALBERO **AL19 RG.H**

Nominal power                    **19 kW**  
 Heating load range            **9-23 kW**  
 Weight                              **273 kg**  
 Glass panel dimensions (mm) **900x415x375**



### ALBERO **AL19 LG.H**

Nominal power                    **19 kW**  
 Heating load range            **9-23 kW**  
 Weight                              **273 kg**  
 Glass panel dimensions (mm) **900x415x375**



ALBERO AL 19 LG.H fireplace insert





ALBERO AL 120x43 G.H fireplace insert

# AL 120x43 G.H FIREPLACE INSERT



EQUIPMENT OF **25 KW SERIES** FIREPLACE INSERTS

- 🔥 Fireplace front coating – black
- 🔥 Handle colour INOX
- 🔥 Ceramic insert
- 🔥 Double ceramic deflector
- 🔥 Double combustion gas throttle
- 🔥 Flue
- 🔥 Regulated feet 40 mm
- 🔥 Fireplace insert without a grate

SCAN QR CODE WITH A READER  
TO GET MORE DETAILED  
TECHNICAL DATA OF **ALBERO**  
**AL 25 kW SERIES** INSERTS



**ALBERO AL 120x43 G.H**

Nominal power	25 kW
Heating load range	12-31 kW
Weight	427 kg
Glass panel dimensions (mm)	1200x430
Thermal efficiency	80%

**FIREPLACE INSERT  
OF HEATING POWER 25 kW**

Convection fireplace insert of ALBERO line of heating power 25 kW is the biggest insert manufactured by HITZE now.

It is an insert without a grate with double throttle. Unlike other fireplaces belonging to Albero line made of 3 mm thick boiler steel, model AL 120x43 is made of thicker 4-mm boiler steel of P265GH grade and according to EN 10028-2.

Albero AL 120x43 GH fireplace insert means the highest quality class, precision and aesthetics of design. High, over 80-percent thermal efficiency is guaranteed by specially designed rear part of the body which allows the secondary air to be supplied to the upper part of the furnace.

In the fireplace door a heat-resistant ceramic glass is installed with working temperature up to 800°C.

The insert is equipped with an air curtain which guarantees keeping clean glass effect to a considerable degree and panoramic view of fire.

# FIREPLACE INSERTS

## WATER JACKET



In fireplace inserts belonging to AQUASYSTEM line a double system of heat emission and recovery was applied. Water jacket is located over a combustion chamber and absorbs heat only from combustion gas.

An insert with water jacket is a combination of traditional convection insert with high heating capacity.







ALBERO AQUASYSTEM ALAQ 59x43.G fireplace insert



---

## ALBERO AQUASYSTEM LINE

The most important advantage of water jacket fireplaces is their high effectiveness of heat use during burning process which has a significant influence on heating efficiency.

It happens due to the use of water jacket which absorbs heat during wood burning and transfers it to the heating system.

Water jacket is located over a combustion chamber and absorbs heat from combustion gas. Such construction keeps high temperature inside the chamber and helps to obtain high efficiency and low emission of carbon dioxide and dust.

Installation of a fireplace with water jacket enables to decrease heating costs even by 40%.

Additional advantage of this type of fireplaces is an ability of connecting them to the solar collectors due to which a heating system will be environment friendly and economical.

ADVANTAGES OF WATER JACKET FIREPLACE INSERTS

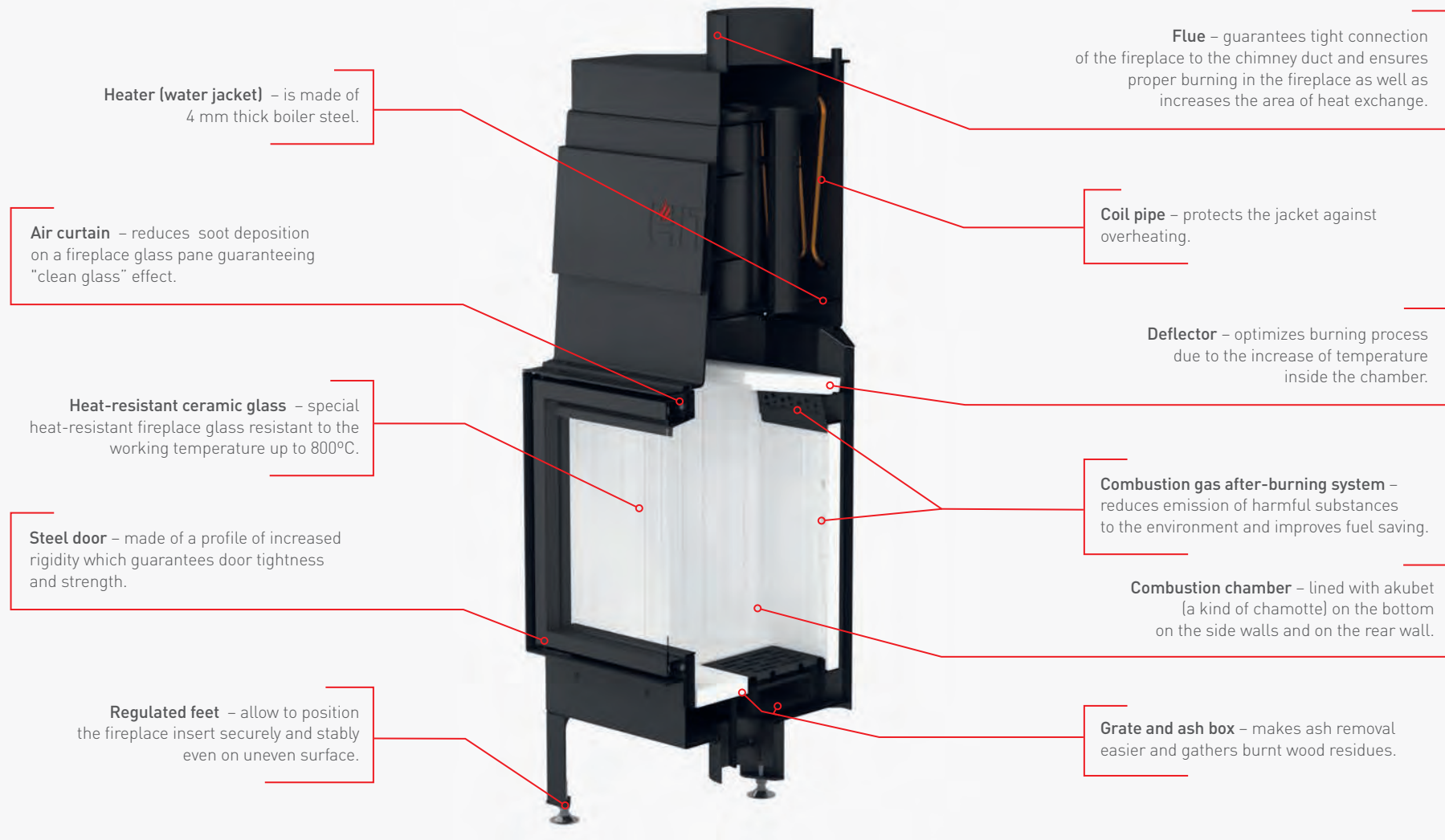





# ALBERO AQUASYSTEM WATER JACKET FIREPLACE INSERTS

ALAQ  
**54x39.S** standard horizontal  
fireplace insert

ALAQ  
**59x43.S** standard horizontal  
fireplace insert

ALAQ  
**54x39.G** guillotine-type  
horizontal fireplace insert

ALAQ  
**59x43.G** guillotine-type  
horizontal fireplace insert

ALAQ  
**68x43.S** standard horizontal  
fireplace insert

## AQUASYSTEM 54x39 SERIES



ALAQ 54x39.S

ALAQ 54x39.G

## AQUASYSTEM 59x43 SERIES



ALAQ 59x43.S

ALAQ 59x43.G

## AQUASYSTEM SERIES



ALAQ 68x43.S

ALAQ **68x53.S** standard horizontal fireplace insert

ALAQ **68x53.G** guillotine-type horizontal fireplace insert

ALAQ **68x43.G** guillotine-type horizontal fireplace insert

ALAQ **90x41.S** standard horizontal fireplace insert

ALAQ **90x41.G** guillotine-type horizontal fireplace insert

## EQUIPMENT OF **AQUASYSTEM LINE** FIREPLACE INSERTS

- 🔥 Fireplace front coating – black
- 🔥 Handle colour INOX
- 🔥 Ceramic insert
- 🔥 Double ceramic deflector
- 🔥 Integrated combustion gas throttle
- 🔥 Flue
- 🔥 Ash pan
- 🔥 Regulated feet 40 mm

**68x43**

**AQUASYSTEM 68x53**  
SERIES

**AQUASYSTEM 90x41**  
SERIES



ALAQ **68x43.G**



ALAQ **68x53.S**



ALAQ **68x53.G**



ALAQ **90x41.S**



ALAQ **90x41.G**

---

# CERAMIC GLASS

---

---

## ACCESSORIES

---



Ceramic glass is used in HITZE fireplace inserts in order to increase their combustion efficiency.

Glass bases are made of tempered glass which protects floor or near the fireplace or the stove against sparks, ash or pieces of incandescent wood.





## CERAMIC GLASS AND GLASS BASES

### HITZE

**Ceramic glass** is used in fireplace inserts produced by our company and it is specially designed in order to increase combustion efficiency.

**Metallic layer** covering the surface of ceramic glass is responsible for absorption of infrared rays. Thermal energy generated in the furnace is not dispersed but it is kept inside and thus it contributes to an increase of fireplace heating capacity to a large extent.

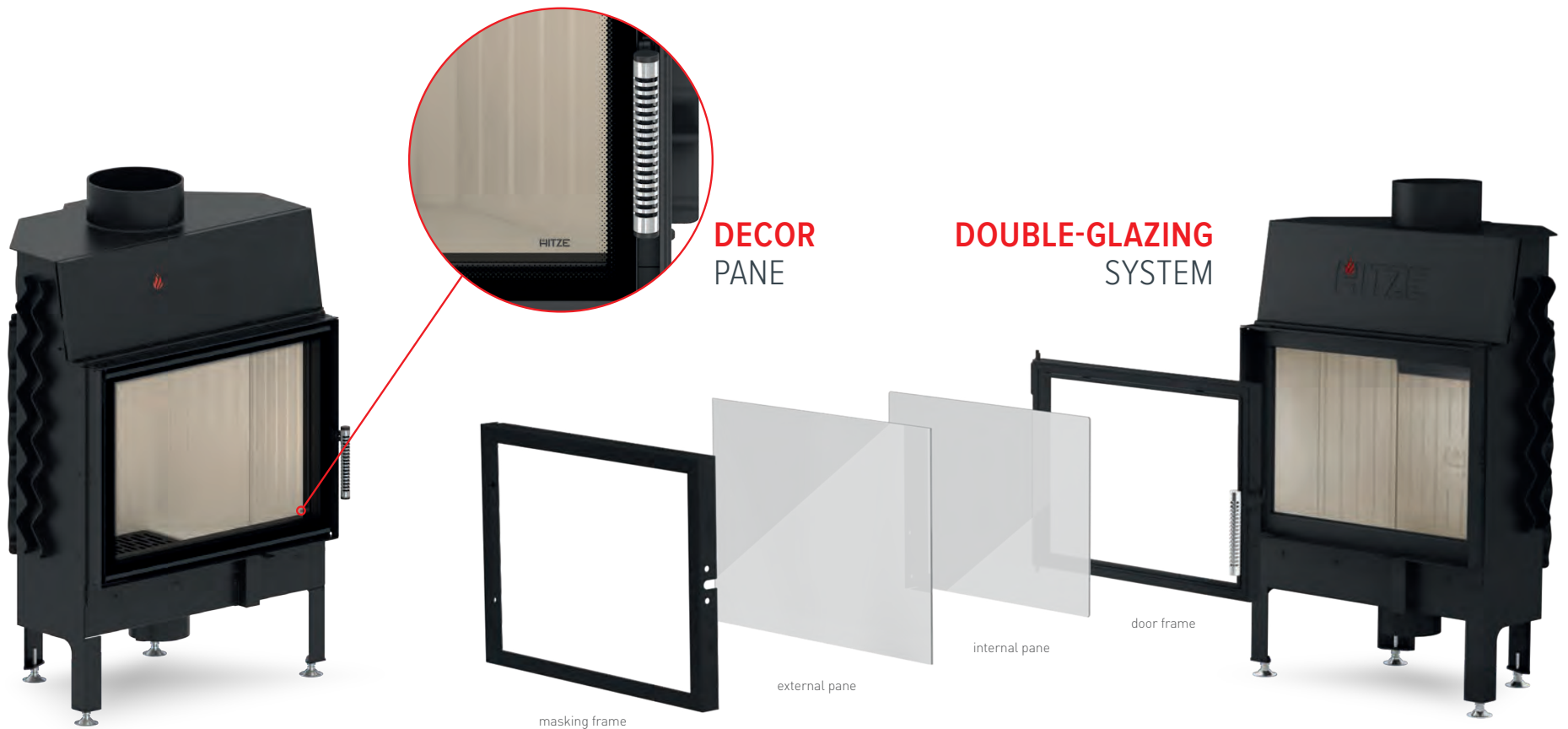



Higher burning temperature reduces soot deposition on a glass pane producing an effect of “**self-cleaning glass**”. It is important especially in case of big furnaces and double-glazing systems, where efficiency and thermal energy saving are essential.

**DECOR** (ornamental pane) version of fireplace glass may be ordered for all fireplace inserts. For corner fireplaces there is also a possibility to order a door with **divided double glass pane** or with **bent glass pane in DECOR or standard version**.

**Hitze glass bases** are made of tempered glass which protects floor near the fireplace or the stove against sparks, ash or pieces of incandescent wood. They are made of 4 mm or 5 mm thick glass and they withstand load up to 600 kg. To ensure safety of use, the base external edges are rounded and polished.

Bases are available in two variants: brown glass and transparent glass and in two dimensions: 1067x1260 mm and 515x359 mm.

## PANE TYPES



DECOR FLAT PANE



DECOR BENT PANE



DECOR DIVIDED PANE



GLASS  
FIREPLACE  
AND PELLET STOVE  
**BASE**

ALBERO AL 16 G.H fireplace insert with glass base

# PELLET STOVES

## CONVECTION



Pellet stoves of Voga line stand out due to their unique heating efficiency and high comfort of use. They are manufactured in four colour versions.

They burn natural renewable fuel that is pellet (granulated wood). It's properties cause low carbon dioxide emission and clean combustion.





VOGA V08AA.S pellet stove



---

## VOGA PELLETS STOVES

Pellet stoves are becoming more and more popular due to their high heating efficiency and comfort of everyday use. Low carbon dioxide emission and clean combustion are their great advantages due to which they generate small ash volume.

Pellet stoves manufactured by HITZE are made of the highest quality boiler steel, resistant to high temperatures.

Pellet stoves of VOGA line were designed for heating interiors based on the principle of thermal radiation convection through glass pane in an automated process of burning pellets, that is natural biofuel of high heating capacity.

Every stove is equipped with outside temperature sensor, combustion gas temperature sensor and STB sensor. Firing up, heating and putting out process is fully automated with a possibility of setting day and night mode.

One-time charge of pellet stove reaches even 30 kg of fuel which allows for maintenance-free operation of up to 36 hours.



**ADVANTAGES OF PELLET STOVES**

**Ceramic insert** – accumulates warmth and is resistant to temperature even up to 1000°C.

**Stove programmer** – enables to programme stove working cycle for every day of a week with automatic firing up function.

**Steel door** – made of a thin profile which guarantees door tightness and rigidity.

**Pellet container** – one-time charge of up to 20 kg of fuel allows for stove operation for up to 24 hours..

**Heat-resistant ceramic glass** – special heat-resistant fireplace glass resistant to the working temperature up to 800°C.

**Pellet conveyor** – feeding screw which provides even fuel charge in automated process of pellet burning.

**Steel housing** – powder coated with temperature resistant paint.

**Ash box** – makes ash removal easier and gathers burnt pellet residues.





# PELLET STOVES

## VOGA LINE

AVAILABLE  
STOVE  
SIDE PANEL  
COLOUR  
OPTIONS

STOVE WITH UPPER CONVEYOR



### VOGA V08AA.S

Nominal power (min/max)	3 / 7,8 kW
Pellet use per hour (min/max)	0,83 / 2,85 kg/h
Pellet container capacity	20 kg
Weight	123 kg
Autonomy (min/max)	7 / 24 h



Available housing colours

STOVE WITH SIDE CONVEYOR



### VOGA V08AB.S

Nominal power (min/max)	3 / 7,8 kW
Pellet use per hour (min/max)	0,83 / 3 kg/h
Pellet container capacity	30 kg
Weight	140 kg
Autonomy (min/max)	10 / 36 h



Available housing colours

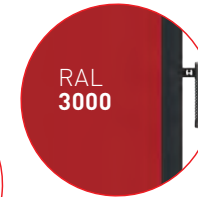
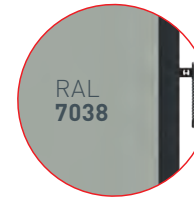

## WHY IS IT WORTH TO COUNT ON PELLET?

### What is pellet?

Pellet is a natural material manufactured from wood waste, such as sawdust and wood shavings, pressed under high pressure. The most popular form of pellet is a granulate of 6 or 8 mm in diameter.

### Pellet and its advantages

Why is pellet becoming more and more popular heating fuel? The answer to this question is simple. We appreciate pellet mainly due to its high heating capacity, low CO2 emission, purity of combustion and comfort of use.

The growing popularity of pellet also results from the small amount of ash that remains after its combustion. All these advantages make pellet an increasingly important fuel of the future.

### In harmony with nature

Pellet is a highly efficient natural renewable fuel. Its production contributes to the decrease in fossil fuels consumption, e.g. coal, and to the reduction of waste management problem. Ash from burnt pellet may be used as safe and harmless garden fertilizer.

If you are looking for completely natural and efficient fuel, pellet will be an ideal solution!



# S U P P L E M E N T A R Y O F F E R



Constant development of our company and qualified team of specialists are a basis for creation of innovative projects and launching new products, such as:

bio torches, series of bio tables, fireplace cassettes as well as heat exchangers and masking frames for fireplace inserts.

bio torches, bio fireplaces,  
bio tables, fireplace cassettes,  
heat exchangers, masking frames.







## BIO TORCHES

Bio torch is a very attractive decorative element which may constitute additional attraction of summer parties in a garden or on patio. It is ideal

for hotel gardens, boarding houses or grill cottages. It also emits heat and creates romantic atmosphere around. Bio torch burns odourless

eco-friendly fuel producing water vapour and carbon dioxide in the process of burning. It is made of stainless steel resistant to high temperatures.



Bio torch is available in three dimensions: Small, Medium and Standard.

BP-01SM  
SMALL



BP-01M  
MEDIUM



BP-01S  
STANDARD





## BIO FIREPLACES

Bio fireplace is an excellent alternative to traditional fireplace.

Ease of assembly and user friendliness together with classical design make it possible to be assembled in almost every interior.

Bio fireplace constitutes a stylish method of creating warm atmosphere in any place. It will work perfectly well in apartments, offices, hotels and other places where we would like to enjoy warmth of flames but it is impossible for technical reasons.

Bio fireplace does not require electric power supply and connection to the chimney, it does not produce smoke, ash and does not emit substances harmful to human health. All these advantages give unlimited arrangement possibilities.

In bio fireplace solid fuel (wood, briquette) was substituted by liquid eco-friendly fuel. Its burning is odourless and safe with emission of only water vapour and CO<sub>2</sub> the amount of which is comparable with the amount of CO<sub>2</sub> breathed out by humans.

We offer bio fireplaces with decorative framing made of powder coated steel in three colours – black, red and grey.



AMBIENT bio fireplace



## BIOSTOLIKI

Bio tables produced by our company are stunningly decorative elements of home furnishing. Due to their soft light source they will create a unique and romantic atmosphere in every space.

They stand out by their original design and shape which may be fitter to every space: terrace, garden, restaurant, hotel, spa. They have glass-ceramic cover resistant to high temperature. They are equipped with fuel bio containers of a capacity from 0.6 to 1.2 l.

RULLO SERIES



IGNIS SERIES



HITZE bio tables are made in three stylistic lines: round – RULLO, high and slender – IGNIS and rectangular – PIATTO. Each bio table line is available in three colour variants: white, black and red.

All details of bio tables are distinguished by their top quality. Steel elements are made of polished stainless steel. Bio tables are safe and they do not need chimney installation. They emit neither smoke nor soot.

colour versions of bio tables



PIATTO SERIES







CUBO 800 fireplace cassette



## CUBO FIREPLACE CASSETTE

Fireplace cassettes are specially designed hearths which may be installed in existing open fireplaces or in newly built ones. Application of a cassette in an open fireplace protects premises against fire and smoke escaping into the room.

CUBO fireplace cassette is equipped with two additional hot air outlets. Due to this, there is a possibility to use heat effectively for heating adjacent rooms. Cassette combustion chamber is lined with material accumulating warmth which increases temperature and improves burning performance.



### CUBO 700 CASSETTE

Nominal power	9 kW
Combustion gas temperature	360°C
Glass panel dimensions (mm)	733x373
Thermal efficiency	72%



### CUBO 800 CASSETTE

Nominal power	11 kW
Combustion gas temperature	360°C
Glass panel dimensions (mm)	833x373
Thermal efficiency	72%

## HEAT EXCHANGERS

Heat exchangers are fireplace attachments the task of which is to recover heat from combustion gases escaping from the fireplace to the chimney duct.

Recovered heat is transferred to water which is present in the attachment and then it is further

transported to all heat receivers in the house. The greatest advantage of this solution is an effective use of energy that is usually lost, even wasted. Moreover, heat exchangers do not require additional fuel consumption which makes them a very economical option. Application of heat exchangers is an excellent choice for owners of convection

fireplaces who do not want to dispense with the current solution and at the same time they see a possibility of using extra energy to heat the house or water.



HEAT EXCHANGER  
air jacket  
**WCPP1.FI200**



HEAT EXCHANGER  
water jacket  
**WCPW01.FI200**



HEAT EXCHANGER  
water jacket with coil pipe  
**WCPW01W.FI200**



HEAT EXCHANGER  
water jacket with pipes  
**WCPW02.FI200**



## MASKING FRAMES

Masking frame shields space between fireplace insert and the door. It is made of 2 mm thick steel powder coated with temperature resistant paint. Additional advantage of masking frames is their easy assembly which you can make by yourself.



MASKING FRAME  
**FAL.SH-M01**



MASKING FRAME  
**FAL.SV-M01**



MASKING FRAME  
**FAL.LH-M01**



MASKING FRAME  
**FAL.LGH-M01**



MASKING FRAME  
**FAL.GH-M01**



MASKING FRAME  
**FAL.GV-M01**



MASKING FRAME  
**FAL.RH-M01**



MASKING FRAME  
**FAL.RGH-M01**

The masking frame is screwed to the frame with the use of M5 screws. Paint colour corresponds to the RAL colour of fireplace insert. Masking frames produced by HITZE suit every model of fireplace insert and are produced for all offered heating powers.



MASKING FRAME  
**FAL.SH-M02**



MASKING FRAME  
**FAL.SV-M02**



MASKING FRAME  
**FAL.LH-M02**



MASKING FRAME  
**FAL.LGH-M02**



MASKING FRAME  
**FAL.GH-M02**



MASKING FRAME  
**FAL.GV-M02**

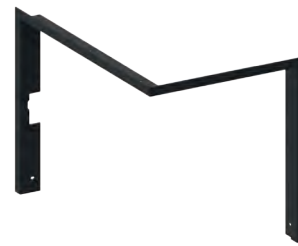

MASKING FRAME  
**FAL.RH-M02**



MASKING FRAME  
**FAL.RGH-M02**



### ALBERO 9 kW series

	AL9 S.H	AL9 S.V	AL9 G.V	AL9 G.H	AL9 R.H	AL9 L.H	AL9 RG.H	AL9 LG.H
Nominal power (kW)	9	9	9	9	9	9	9	9
Heating load range (kW)	5-10	5-12	5-12	5-10	5-10	5-10	5-10	5-12
Flue diameter (mm)	180	180	180	180	180	180	180	180
Thermal efficiency (%)	78,2	78,1	78,1	78,2	78,2	78,2	78,2	78,2
CO emission (przy 13% O <sub>2</sub> )	0,066	0,082	0,082	0,066	0,066	0,066	0,066	0,066
Dust emission (g/m <sup>3</sup> )	0,036	0,03	0,03	0,036	0,036	0,036	0,036	0,036
Combustion gas temperature (°C)	194	316	316	194	194	194	194	194
Weight (kg)	102	105	167	156	109	109	170	170
Maximum log length (cm)	30	30	30	30	30	30	30	30
Material	3 mm boiler steel P265GH							
Type of fuel	Recommended seasoned hardwood, briquette and lignite are admissible							
Min. active field of outlet grilles (cm <sup>2</sup> )	900	1000	1000	900	900	900	900	900
Min. active field of inlet grilles (cm <sup>2</sup> )	700	800	800	700	700	700	700	700
Glass panel dimensions (mm)	545x390	390x545	390x545	545x390	545x390x325	545x390x325	545x390x325	545x390x325
Fireplace insert depth (mm)	530x260	375x260	375x260	530x260	479x260	479x260	479x260	479x260

### ALBERO 11 kW series

	AL11 S.H	AL11 S.V	AL11 G.V	AL11 G.H	AL11 R.H	AL11 L.H	AL11 RG.H	AL11 LG.H
Nominal power (kW)	11	11	11	11	11	11	11	11
Heating load range (kW)	6-13	6-12	6-12	6-13	6-13	6-13	6-13	6-13
Flue diameter (mm)	200	200	200	200	200	200	200	200
Thermal efficiency (%)	84	87,4	87,4	84	84	84	84	84
CO emission (przy 13% O <sub>2</sub> )	0,099	0,08	0,08	0,099	0,099	0,099	0,099	0,099
Dust emission (g/m <sup>3</sup> )	0,038	0,023	0,023	0,038	0,038	0,038	0,038	0,038
Combustion gas temperature (°C)	220,5	184	184	220,5	220,5	220,5	220,5	220,5
Weight (kg)	131	118	190	182	144	144	186	186
Maximum log length (cm)	40	40	40	40	40	40	40	40
Material	3 mm boiler steel P265GH							
Type of fuel	Recommended seasoned hardwood, briquette and lignite are admissible							
Min. active field of outlet grilles (cm <sup>2</sup> )	1000	1000	1000	1000	1000	1000	1000	1000
Min. active field of inlet grilles (cm <sup>2</sup> )	800	800	800	800	800	800	800	800
Glass panel dimensions (mm)	590x430	430x590	430x590	590x430	590x430x375	590x430x375	590x430x375	590x430x375
Fireplace insert depth (mm)	575x310	415x310	515x310	575x310	524x310	524x310	524x310	524x310



**ALBERO 14 kW series**

	AL14 S.H	AL14 S.V	AL14 G.H	AL14 R.H	AL14 L.H	AL14 RG.H	AL14 LG.H
Nominal power (kW)	14	14	14	14	14	14	14
Heating load range (kW)	7-16	7-16	7-16	7-16	7-16	7-16	7-16
Flue diameter (mm)	200	200	200	200	200	200	200
Thermal efficiency (%)	82,9	83,6	82,9	82,9	82,9	82,9	82,9
CO emission (przy 13% O <sub>2</sub> )	0,068	0,096	0,068	0,068	0,068	0,068	0,068
Dust emission (g/m <sup>3</sup> )	0,032	0,038	0,032	0,032	0,032	0,032	0,032
Combustion gas temperature (°C)	241	256	241	241	241	241	241
Weight (kg)	144	145	195	150	150	200	200
Maximum log length (cm)	40	30	40	40	40	40	40
Material	3 mm boiler steel P265GH						
Type of fuel	Recommended seasoned hardwood, briquette and lignite are admissible						
Min. active field of outlet grilles (cm <sup>2</sup> )	1000	1000	1000	1000	1000	1000	1000
Min. active field of inlet grilles (cm <sup>2</sup> )	800	800	800	800	800	800	800
Glass panel dimensions (mm)	680x430	430x680	680x430	680x430x375	680x430x375	680x430x375	680x430x375
Fireplace insert depth (mm)	665x310	415x310	665x310	614x310	614x310	614x310	614x310

**ALBERO 16 kW series**

	AL16 S.H	AL16 G.H	AL16 R.H	AL16 L.H	AL16 RG.H	AL16 LG.H
Nominal power (kW)	16	16	16	16	16	16
Heating load range (kW)	8-19	8-19	8-19	8-19	8-19	8-19
Flue diameter (mm)	200	200	200	200	200	200
Thermal efficiency (%)	81,1	81,1	81,1	81,1	81,1	81,1
CO emission (przy 13% O <sub>2</sub> )	0,063	0,063	0,063	0,063	0,063	0,063
Dust emission (g/m <sup>3</sup> )	0,033	0,033	0,033	0,033	0,033	0,033
Combustion gas temperature (°C)	318	318	318	318	318	318
Weight (kg)	159	223	157	157	220	220
Maximum log length (cm)	40	40	40	40	40	40
Material	3 mm boiler steel P265GH					
Type of fuel	Recommended seasoned hardwood, briquette and lignite are admissible					
Min. active field of outlet grilles (cm <sup>2</sup> )	1000	1000	1000	1000	1000	1000
Min. active field of inlet grilles (cm <sup>2</sup> )	800	800	800	800	800	800
Glass panel dimensions (mm)	680x530	680x530	680x530x375	680x530x375	680x530x375	680x530x375
Fireplace insert depth (mm)	665x310	665x310	614x310	614x310	614x310	614x310



### ALBERO 19 kW series

	AL19 S.H	AL19 G.H	AL19 R.H	AL19 L.H	AL19 RG.H	AL19 LG.H
Nominal power (kW)	19	19	19	19	19	19
Heating load range (kW)	9-23	9-23	9-23	9-23	9-23	9-23
Flue diameter (mm)	220	220	220	220	220	220
Thermal efficiency (%)	81,6	81,6	81,6	81,6	81,6	81,6
CO emission (przy 13% O <sub>2</sub> )	0,096	0,096	0,096	0,096	0,096	0,096
Dust emission (g/m <sup>3</sup> )	0,029	0,029	0,029	0,029	0,029	0,029
Combustion gas temperature (°C)	314	314	314	314	314	314
Weight (kg)	200	258	202	202	273	273
Maximum log length (cm)	70	70	70	70	70	70
Material	3 mm boiler steel P265GH					
Type of fuel	Recommended seasoned hardwood, briquette and lignite are admissible					
Min. active field of outlet grilles (cm <sup>2</sup> )	1000	1000	1000	1000	1000	1000
Min. active field of inlet grilles (cm <sup>2</sup> )	800	800	800	800	800	800
Glass panel dimensions (mm)	900x415	900x415	900x415x375	900x415x375	900x415x375	900x415x375
Fireplace insert depth (mm)	885x310	885x310	834x310	834x310	834x310	834x310

### ALBERO 25 kW series

	AL120x43 G.H
Nominal power (kW)	25
Heating load range (kW)	12-31
Flue diameter (mm)	250
Thermal efficiency (%)	80
CO emission (przy 13% O <sub>2</sub> )	0,097
Dust emission (g/m <sup>3</sup> )	0,038
Combustion gas temperature (°C)	286
Weight with pallet (kg)	427
Maximum log length (cm)	60-90
Material	4 mm boiler steel P265GH
Type of fuel	Recommended seasoned hardwood, briquette and lignite are admissible
Min. active field of outlet grilles (cm <sup>2</sup> )	1000
Min. active field of inlet grilles (cm <sup>2</sup> )	800
Glass panel dimensions (mm)	1200x430
Fireplace insert depth (mm)	1183x392

### ALBERO ALAQ series

	ALAQ59x43.S
Nominal power (kW)	13,6
Thermal efficiency (%)	86,3
Thermal power delivered to room (kW)	8
Thermal power of water circulation (kW)	5,6
Fireplace insert body	3 mm boiler steel P265GH
Heater (water jacket)	4 mm boiler steel P265GH

**PELLET STOVES**

	VOGA V08AA.S	VOGA V08AB.S
Nominal power min/max (kW)	3 / 7,8	3 / 7,8
Pellet use per hour min/max (kg/h)	0,83 / 2,85	0,83 / 3
Thermal efficiency (%)	85,4	85,4
Combustion gas outlet diameter (mm)	80	80
Air inlet diameter (mm)	40	40
Pellet container capacity (kg)	20	30
Autonomy min/max (h)	7 / 24	10 / 36
Power consumption (W)	55 (355)	55 (355)
Weight (kg)	123	140

**BIO TABLES**

	RULLO	PIATTO	IGNIS
Height (mm)	770	335	1239
Top diameter (mm)	Ø 800	1200x600	Ø 400
Top thickness (mm)	40	50	10
Bio container capacity (l)	1,2	0,6	1,2
Top material	painted MDF board		stone - glass glass
Basic material	stainless steel		
Protective cover material	ceramic glass		

**FIREPLACE CASSETTES**

	CUBO 700	CUBO 800
Nominal power (kW)	9	11
Flue diameter (mm)	150	150
Thermal efficiency (%)	72	72
Combustion gas temperature (°C)	360	360
Weight (kg)	115	140
Maximum log length (cm)	40	40
Type of fuel	Recommended seasoned hardwood, briquette and lignite are admissible	
Glass panel dimensions (mm)	733x373	833x373

**HEAT EXCHANGERS**

	WCPP1.FI200 air jacket	WCPW01.FI200 water jacket	WCPW01W.FI200 water jacket with coil pipe	WCPW02.FI200 water jacket with pipes
Power (kW)	do 7	do 7	do 7	do 10
Material	3 mm boiler steel			4 mm boiler steel
Weight (kg)	22	23	23	63

HITZE reserves the right to introduce changes in technical parameters, equipment and specifications of offered products. Information contained in the catalogue is for reference only and it does not constitute an offer under the Civil Code regulations.



**Masking frame**  
**M01 type - AL9 series**

	masking frame dimenions [mm]		
	width	height	depth
AL9 S.H	623	462	-
AL9 S.V	468	617	-
AL9 G.V	478	637	-
AL9 G.H	633	482	-
AL9 R.H	609	463	390
AL9 L.H	609	463	390
AL9 RG.H	670	482	451
AL9 LG.H	670	482	451

**Masking frame**  
**M01 type - AL11 series**

	masking frame dimenions [mm]		
	width	height	depth
AL11 S.H	668	502	-
AL11 S.V	508	662	-
AL11 G.V	518	682	-
AL11 G.H	678	522	-
AL11 R.H	653	503	439
AL11 L.H	653	503	439
AL11 RG.H	715	522	501
AL11 LG.H	715	522	501

**Masking frame**  
**M01 type - AL14 series**

	masking frame dimenions [mm]		
	width	height	depth
AL14 S.H	758	502	-
AL14 S.V	508	752	-
AL14 G.H	768	522	-
AL14 R.H	743	503	439
AL14 L.H	743	503	439
AL14 RG.H	805	622	501
AL14 LG.H	805	622	501

**Masking frame**  
**M01 type - AL16 series**

	masking frame dimenions [mm]		
	width	height	depth
AL16 S.H	758	602	-
AL16 G.H	768	622	-
AL16 R.H	743	603	439
AL16 L.H	743	603	439
AL16 RG.H	805	622	501
AL16 LG.H	805	622	501

**Masking frame**  
**M01 type - AL19 series**

	masking frame dimenions [mm]		
	width	height	depth
AL19 S.H	978	487	-
AL19 G.H	988	507	-
AL19 R.H	963	487	439
AL19 L.H	963	487	439
AL19 RG.H	1025	507	501
AL19 LG.H	1025	507	501

**Masking frame**  
**M01 type - AL120x43**

	masking frame dimenions [mm]		
	width	height	depth
AL120x43 G.H	1271	527	-

**Masking frame**  
**M02 type - AL9 series**

masking frame dimenions [mm]		
width	height	depth
AL9 S.H	623	439
AL9 S.V	468	594
AL9 G.V	478	614
AL9 G.H	633	459
AL9 R.H	609	440
AL9 L.H	609	440
AL9 RG.H	670	459
AL9 LG.H	670	459

**Masking frame**  
**M02 type - AL11 series**

masking frame dimenions [mm]		
width	height	depth
AL11 S.H	668	479
AL11 S.V	508	639
AL11 G.V	518	659
AL11 G.H	678	499
AL11 R.H	653	480
AL11 L.H	653	480
AL11 RG.H	715	499
AL11 LG.H	715	499

**Masking frame**  
**M02 type - AL14 series**

masking frame dimenions [mm]		
width	height	depth
AL14 S.H	668	479
AL14 S.V	508	729
AL14 G.H	768	499
AL14 R.H	743	480
AL14 L.H	743	480
AL14 RG.H	805	499
AL14 LG.H	805	499

**Masking frame**  
**M02 type - AL16 series**

masking frame dimenions [mm]		
width	height	depth
AL16 S.H	758	579
AL16 G.H	768	599
AL16 R.H	743	580
AL16 L.H	743	580
AL16 RG.H	805	599
AL16 LG.H	805	599

**Masking frame**  
**M02 type - AL19 series**

masking frame dimenions [mm]		
width	height	depth
AL19 S.H	978	464
AL19 G.H	988	484
AL19 R.H	963	464
AL19 L.H	963	464
AL19 RG.H	1025	484
AL19 LG.H	1025	484

**Masking frame**  
**M02 type - AL120x43**

masking frame dimenions [mm]		
width	height	depth
AL120x43 G.H	1271	504





## WARRANTY TERMS AND CONDITIONS – FIREPLACE INSERTS AND STOVES

Below you will find detailed information regarding warranty conditions for fireplace inserts and stoves from our offer.

### GENERAL INFORMATION

Our products are of the highest quality, produced in accordance with the latest knowledge and technology. Materials used for their production have been carefully selected to enjoy their users. We are informing that installation of our products requires specialized knowledge and therefore we recommend that the installation should be performed by persons or companies having necessary expertise in this domain.

### 01. CONTRACTUAL WARRANTY

Warranty for products of HITZE Sp. z o.o. with its registered seat in Radom, is granted for a period of 60 months from the date of purchase.

The basis for the use of the powers under this warranty is the warranty card, together with a proof of purchase in the form of a receipt or invoice. Product purchase should be confirmed in the Warranty Card with a date and legible signature of the seller and the stamp and signature of the person or company performing the product assembly.

The manufacturer provides free of charge warranty repair of the product in case of manufacturing defects (assembly or production), arising during the manufacturing process of the device.

During the warranty period, Hitze Sp. z o.o. with its registered seat in Radom, will replace the part recognized as defective, provided the defective part of the Product is returned to the distributor. Manufacturer's warranty entitles to a free of charge supply of parts needed to restore the device's efficiency after the approval of the Warranty Service.

It is stipulated that replacement or repair of the product parts under this warranty does not extend the duration of this Warranty. Costs of transport of parts to the warranty service shall be borne by the Buyer.

### 02. LIMITATIONS, EXCLUSIONS AND CASES NOT COVERED BY THE WARRANTY

Our products - stoves and fireplace inserts - are covered by warranty for any physical defects originated in the manufacturing process or material defects, within the limits determined below:

Parts subject to wear and tear, such as: handles, grips, moving parts are not covered by the warranty. The warranty does not cover also the cases of product misuse consisting in, but not limited to, product modification by removing all or some seals, modification of air inlets, insert constructional changes or other cases of intervention into the substance of the product.

The manufacturer shall bear no responsibility for the lack of efficiency and damages arising from faulty assembly and operation carried out at variance with instructions and the rules of law related to the installation and operation, i.e. the use of the product.

The warranty covers only cases of product installation carried out by persons or companies that specialize in this kind of operations, i.e. having necessary qualifications, knowledge and experience in this respect.

### 03. WARRANTY EXCLUSIONS

The warranty also does not cover damages caused by:

- » use of fuels other than those recommended by the seller or manufacturer,
- » burning of coal waste, synthetic materials, petroleum derivatives,
- » pouring water over the hearth,
- » sudden lighting the fire in the cold hearth,
- » any mechanical damages,
- » negligent use, including lack of regular product cleaning,
- » improper product maintenance,
- » misuse or inappropriate use of the product,
- » corrosion - inserts must be protected from moisture,
- » incorrect flue draft,
- » defects caused by transport or improper securing of the product during transport.

### 04. REDUCED WARRANTY PERIOD

Subassemblies listed below, i.e.

- » ash pan elements,
- » grate,
- » seals

are covered by a 12-month warranty period, starting from the date of product purchase.

### 05. TERMS OF USE OF WARRANTY RIGHTS

Contractual warranty applies to all products installed and used in accordance with the Instructions for Installation and use, given together with the product at the time of purchase. For the use of the rights under this warranty, it is necessary to notify the seller and present the original or copy of the purchase document i.e. receipt or invoice and the original Warranty Card. In order to lodge a complaint, the Buyer shall accordingly:









HITZE Sp. z o.o.  
ul Gdyńska 32  
26-600 Radom, POLAND

phone: +48 48 380 18 98  
helpline: +48 0 800 88 00 30  
email: [handlowy@hitze.com](mailto:handlowy@hitze.com)  
[www.hitze.com](http://www.hitze.com)

NIP 9482603545  
REGON 361379132  
KRS 0000555859

Authorised distributor



[facebook.com/KominkiHitze](https://facebook.com/KominkiHitze)

1/2017

